

Renfert

making work easy



EASY view 3D

Configuration examples

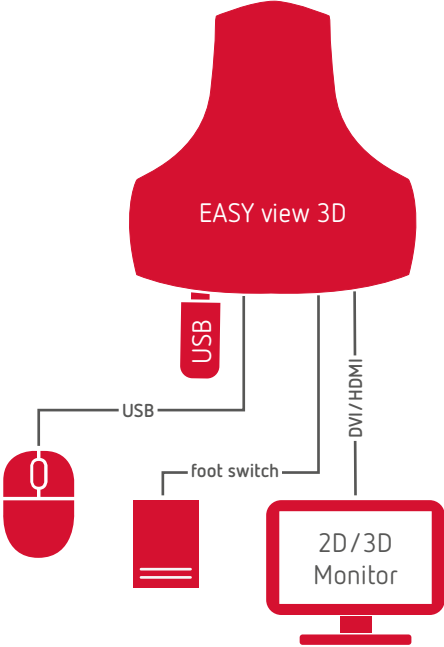

Standard configuration for single EASYview 3D user



-  Renfert standard hardware
-  Renfert optional hardware
-  Hardware available separately*

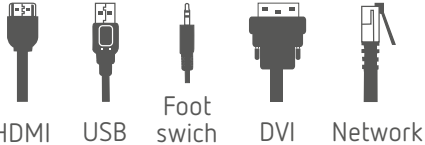

*The error-free operation of additional, non-Renfert, external hardware is not guaranteed

Configuration example for communication (photo exchange) through PC via Network

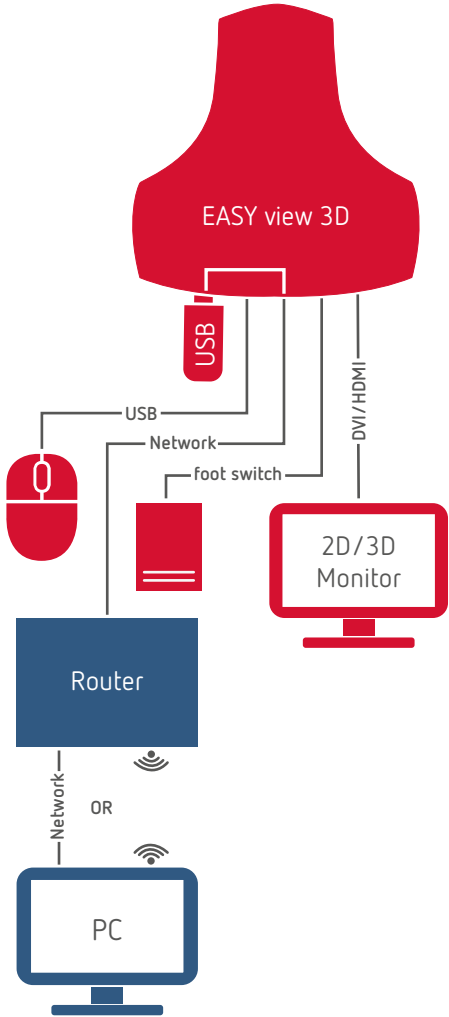

- Renfert standard hardware
- Renfert optional hardware
- Hardware available separately*

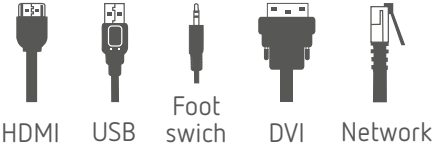

*The error-free operation of additional, non-Renfert, external hardware is not guaranteed

Suitable for one user and one observer via Renfert EASY view 3D monitor (2D/3D)

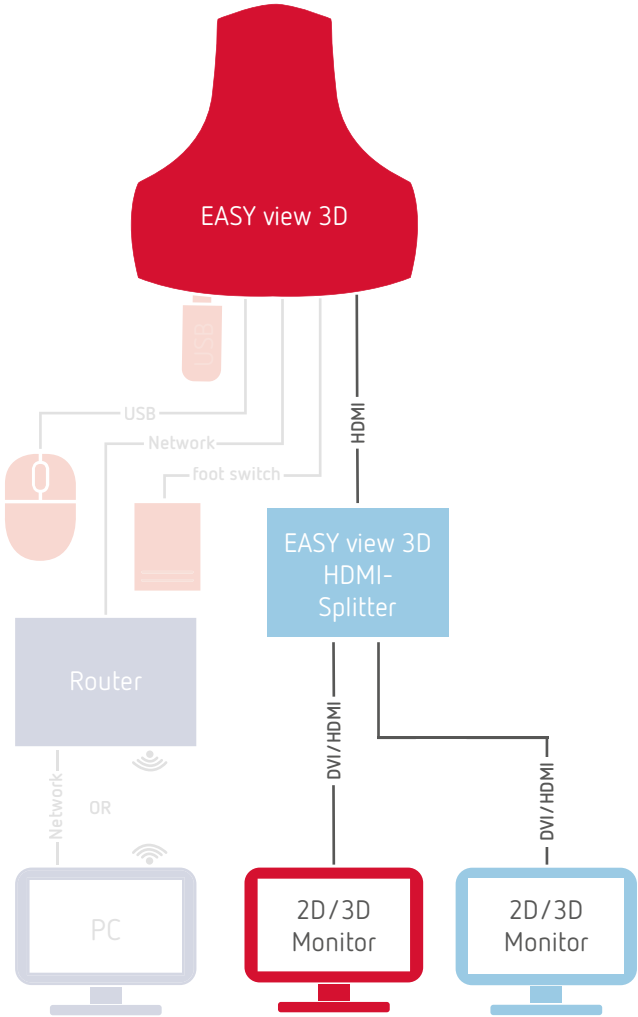



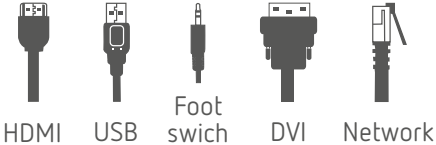

- Renfert standard hardware
- Renfert optional hardware
- Hardware available separately*

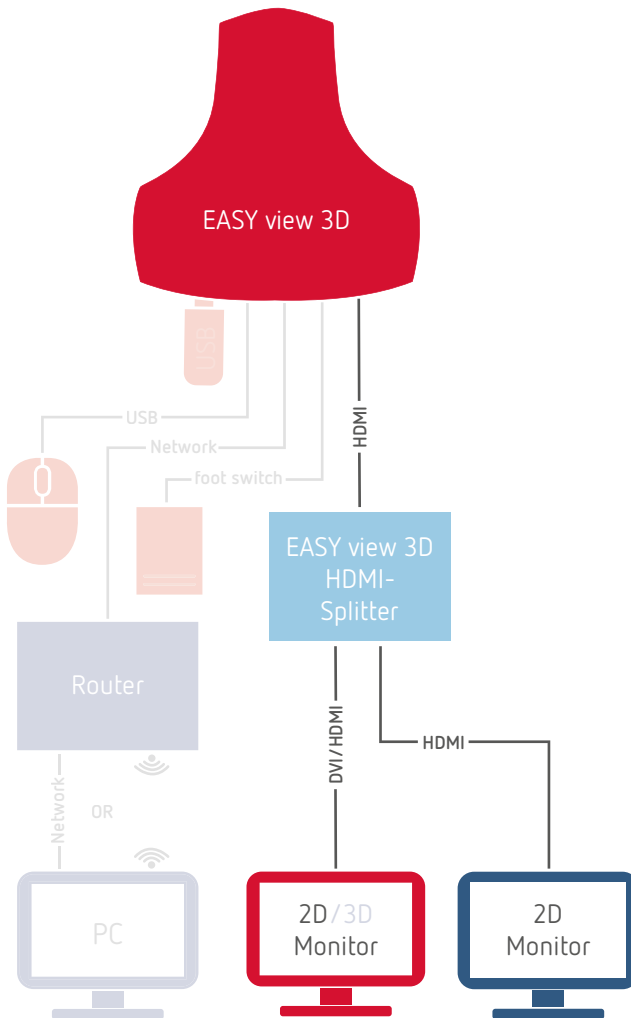

*The error-free operation of additional, non-Renfert, external hardware is not guaranteed

Suitable for one user and one observer via PC monitor (only 2D)



-  Renfert standard hardware
-  Renfert optional hardware
-  Hardware available separately*



HDMI



USB



Foot switch



DVI





Network

*The error-free operation of additional, non-Renfert, external hardware is not guaranteed

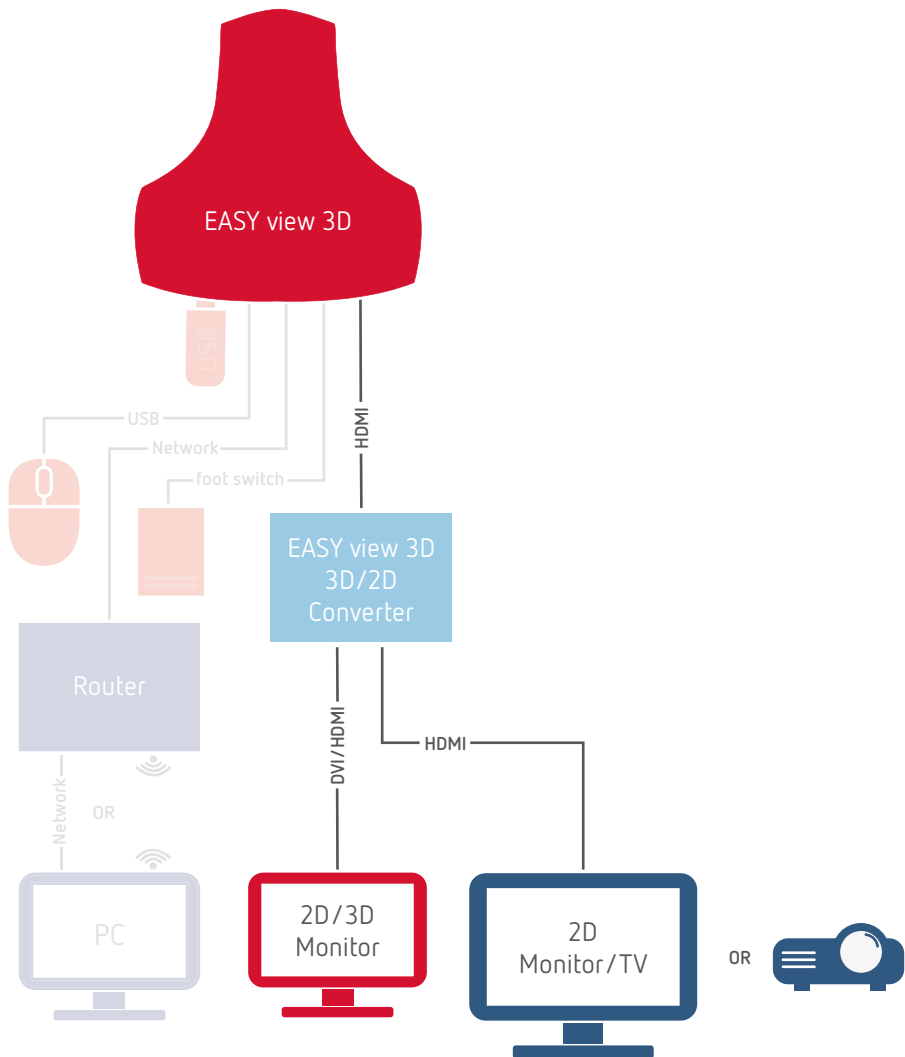
Suitable for one user and one or several observers
via all monitors (PC/TV) or projectors (2D)



-  Renfert standard hardware
-  Renfert optional hardware
-  Hardware available separately*



HDMI



USB



Foot
switch



DVI



Network

*The error-free operation of additional, non-Renfert, external hardware is not guaranteed

Configuration suitable for one user and two observers with separate PC monitors (only 2D)

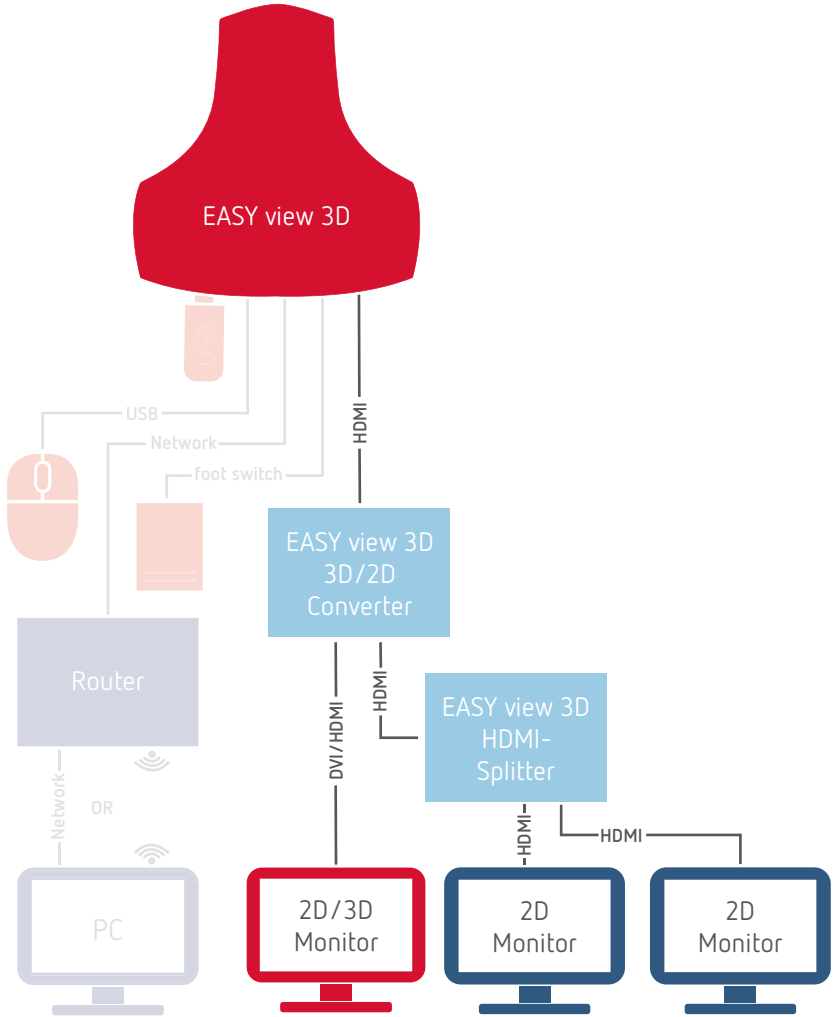



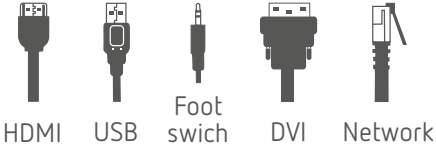

- Renfert standard hardware
- Renfert optional hardware
- Hardware available separately*

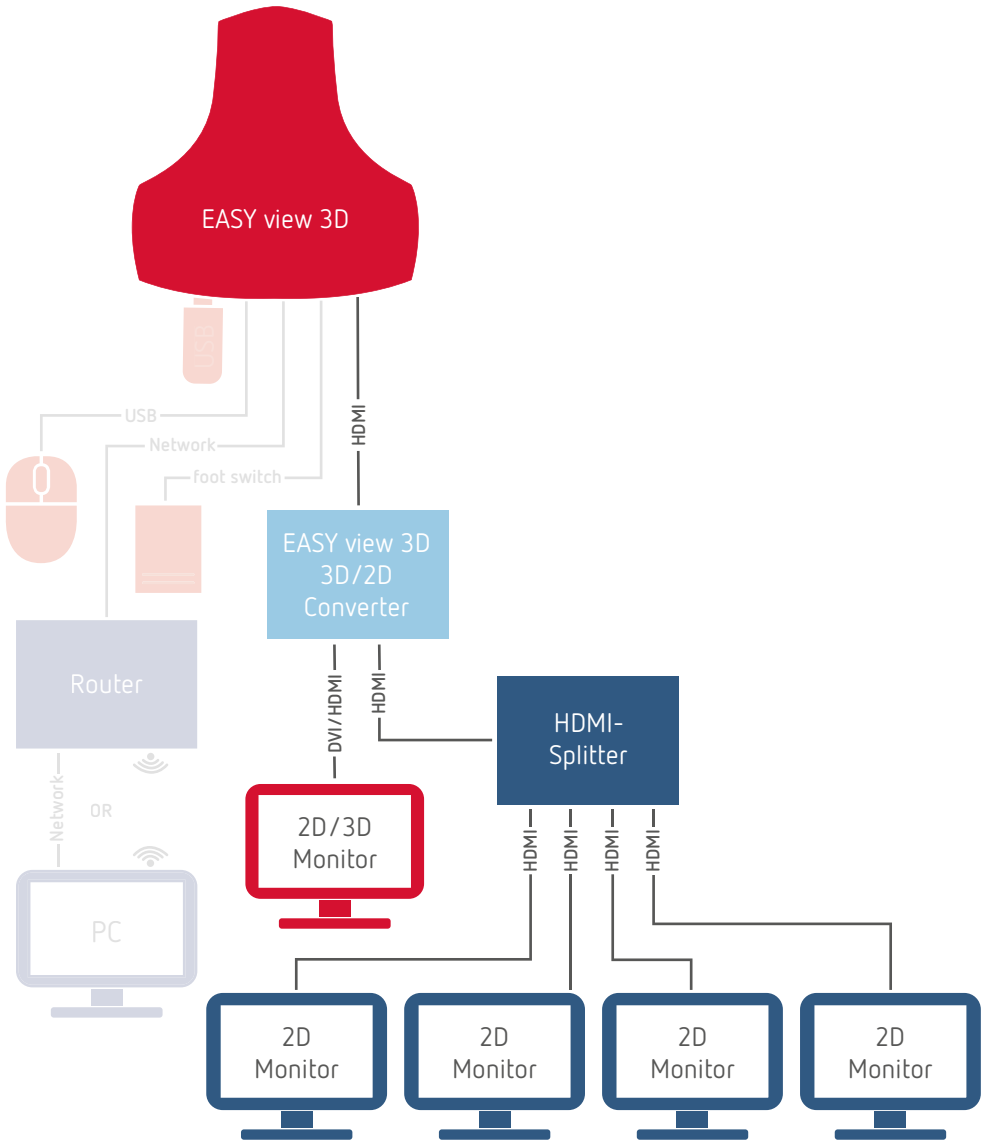

*The error-free operation of additional, non-Renfert, external hardware is not guaranteed

Suitable for one EASYview 3D user and up to 4 observers with individual monitors





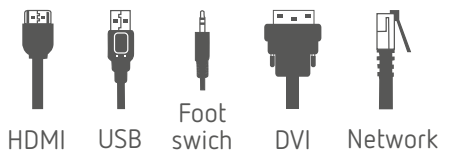

-  Renfert standard hardware
-  Renfert optional hardware
-  Hardware available separately*

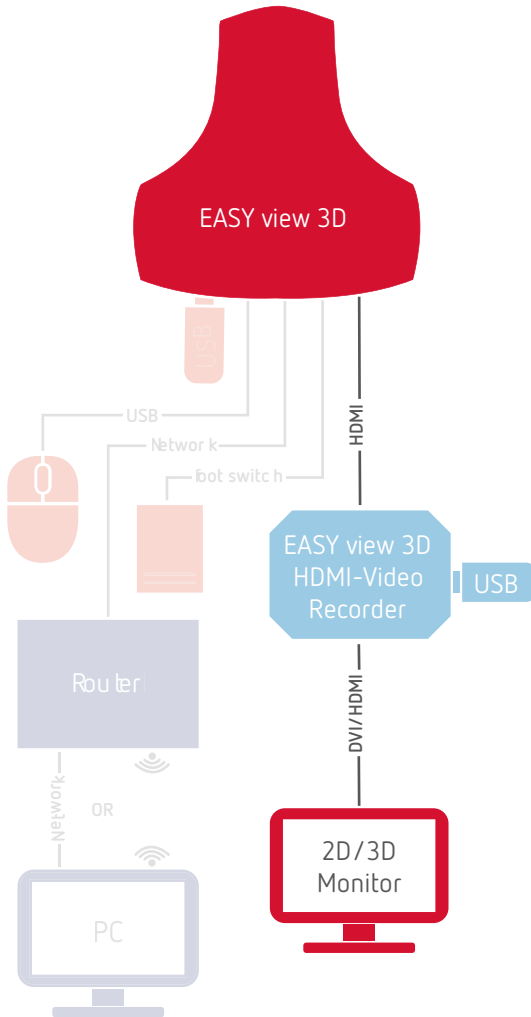

*The error-free operation of additional, non-Renfert, external hardware is not guaranteed

Configuration example including video capture option



-  Renfert standard hardware
-  Renfert optional hardware
-  Hardware available separately*

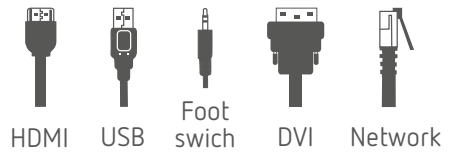

*The error-free operation of additional, non-Renfert, external hardware is not guaranteed

Configuration for EASYview 3D including video capture option plus an additional observer via monitor/projector

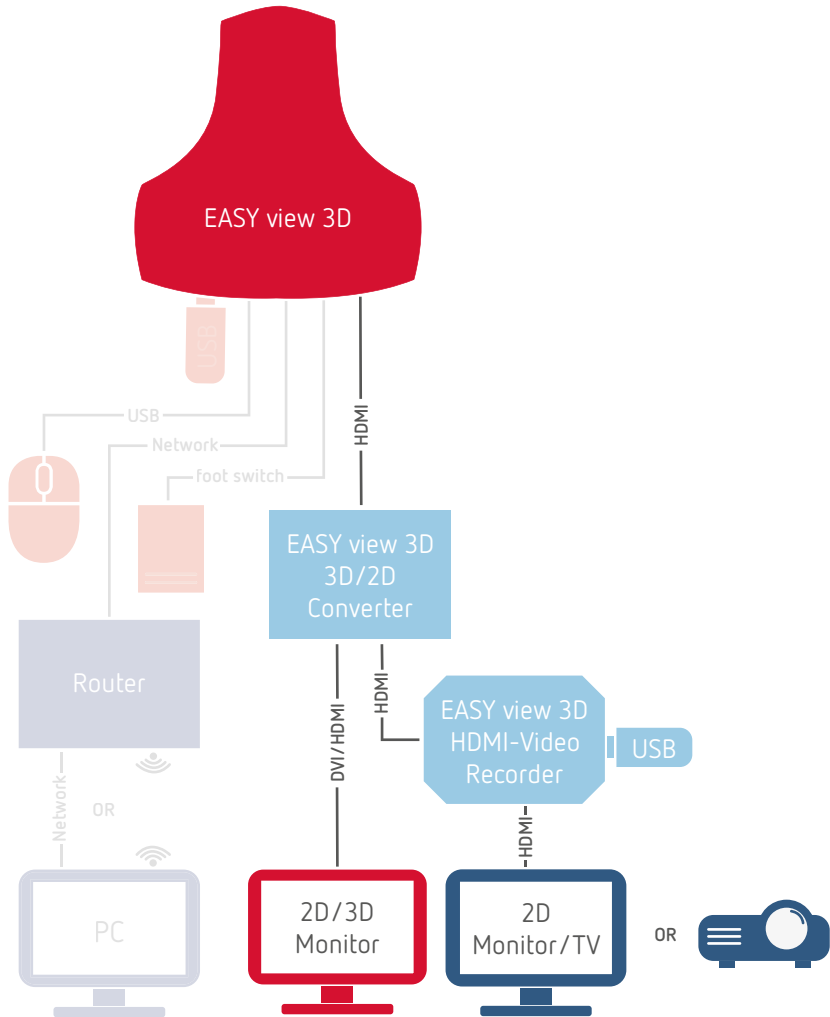

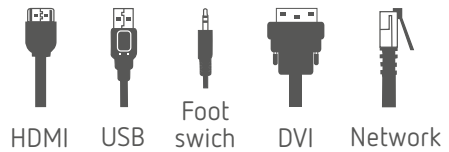

- Renfert standard hardware
- Renfert optional hardware
- Hardware available separately*



*The error-free operation of additional, non-Renfert, external hardware is not guaranteed

Renfert optional hardware

	No. 2400 0501	EASYview 3D Converter 3D/2D	Converts a 3D-signal to a 2D-signal required when connecting an additional output device (ex: monitor, projector). Suitable for Europe excluding GB, IT, DK, FL, CH.
	No. 2400 0506	EASYview 3D Converter 3D/2D with multi voltage power adapter	Converts a 3D-signal to a 2D-signal required when connecting an additional output device (ex: monitor, projector). Suitable worldwide excluding European countries with CEE 7/3 socket.
	No. 2400 0502	EASYview 3D HDMI-Video-Recorder	For recording video and sound sequences. Suitable for Europe excluding GB, IT, DK, FL, CH.
	No. 2400 0504	EASYview 3D HDMI-Video-Recorder with multi voltage power adapter	For recording video and sound sequences. Suitable worldwide excluding European countries with CEE 7/3 socket.
	No. 2400 0503	EASYview 3D HDMI-Splitter	Transmits (unaltered) 3D or 2D signals required when connecting additional 1-2 monitors (or projector). Suitable for Europe excluding GB, IT, DK, FL, CH.
	No. 2400 0505	EASYview 3D HDMI-Splitter with multi voltage power adapter	Transmits (unaltered) 3D or 2D signals required when connecting additional 1-2 monitors (or projector). Suitable worldwide excluding European countries with CEE 7/3 socket.

renfert.com/EASY-view-3D